

IGNITE XL

Models

XLF50

XLF60

XLF74

XLF100

Installation and User's Guide

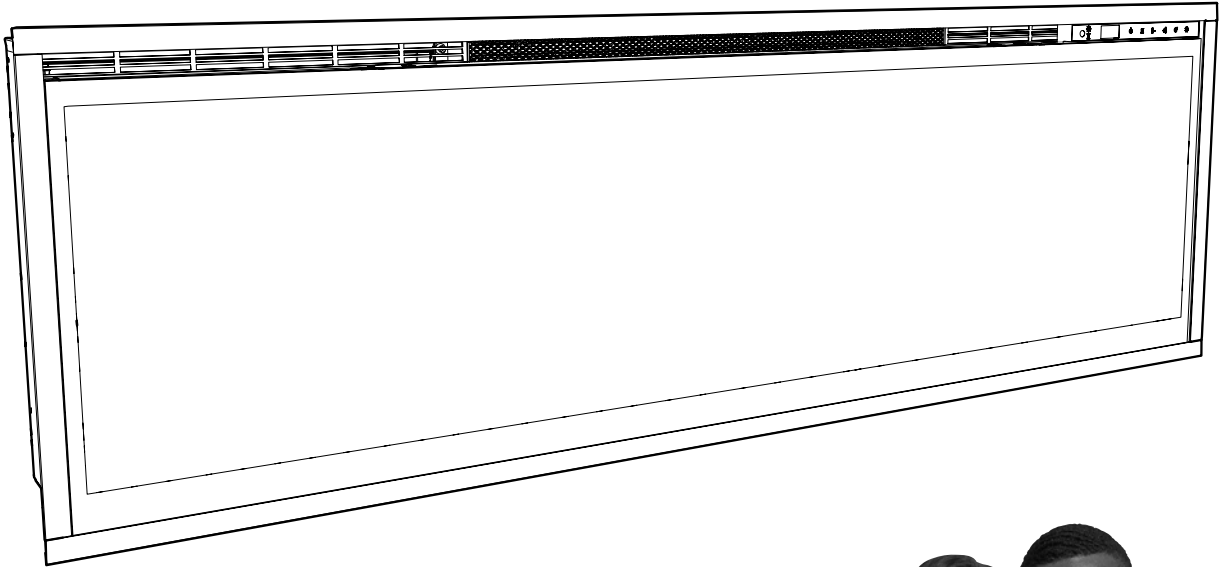

We value your feedback!

Your input helps to create even better products and experiences.

Share the warmth and leave a review.

dimplex.com/sharethewarmth

 [YouTube/Dimplex](https://www.youtube.com/Dimplex) 



IMPORTANT SAFETY INFORMATION:

Read this manual first before attempting to install or use this electric fireplace. Always comply with the warnings and safety instructions contained in this manual to prevent personal injury or property damage.

To view the full line of Dimplex products, visit www.dimplex.com

Table of Contents

Welcome	3
⚠ IMPORTANT INSTRUCTIONS	4
Technical Specifications	6
Electrical Rating	6
UL Listing	6
Product Dimensions	6
Package Contents	7
Installation	9
Placement	9
Installation Instructions	10
Electrical Installation	12
Heater Hardware Disconnect	14
Mirrored Glass Installation	15
Media Arrangement	15
Front Glass Installation	16
Operation	17
General Operation	17
Hidden Touch Controls	17
Remote Operation	17
Resetting the Temperature Cutoff Switch	19
Maintenance	20
Remote Control Battery Replacement	20
Cleaning	20
Servicing	20
Troubleshooting	21
Wiring Diagrams	22
Warranty	23

Conventions used in this manual:

! **NOTE:** Procedures and techniques that are considered important enough to emphasize.

⚠ **CAUTION:** Procedures and techniques which, if not carefully followed, will result in damage to the equipment.

⚠ **WARNING:** Procedures and techniques which, if not carefully followed, will expose the user to the risk of fire, serious injury, or death.

Welcome

Thank you and congratulations for choosing to purchase a Dimplex fireplace.

Please carefully read and save these instructions.

⚠ WARNING: Read all instructions and warnings carefully before starting installation. Failure to follow these instructions may result in a possible electric shock, fire hazard and will void the warranty.

Please record your model and serial numbers for future reference. Model and serial numbers can be found on the label located behind the front glass of your fireplace.

Model _____ MOD _____
Serial Number _____

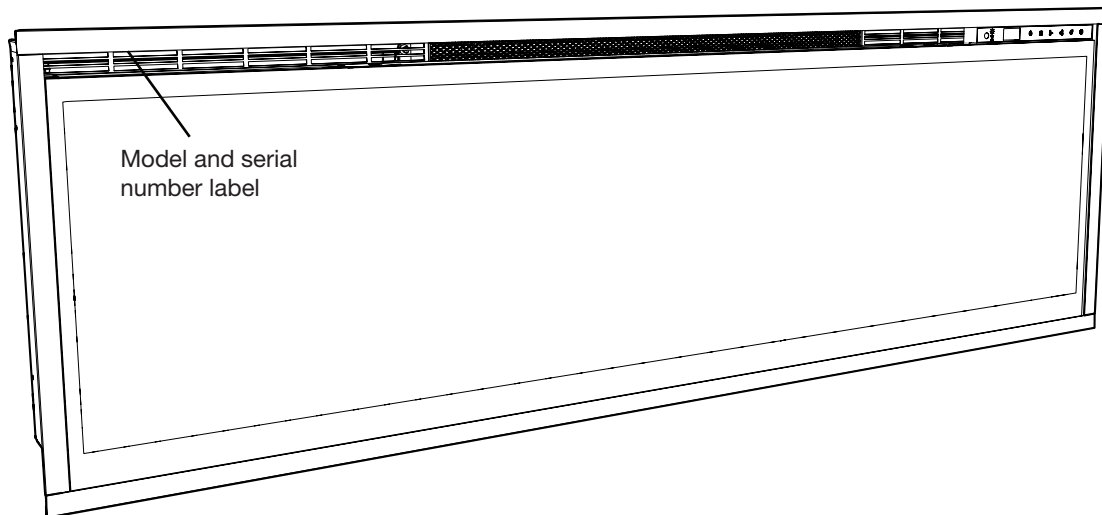

NO NEED TO RETURN TO THE STORE

If you have questions regarding the operation of this product or if you require service, before returning this product to the place of purchase,

Contact us at:  www.dimplex.com/support

For Troubleshooting and Technical Support

OR  **Toll-Free 1-888-346-7539**

Please have your model number and product serial number ready.

IMPORTANT INSTRUCTIONS

When using any electrical appliance, basic precautions should always be followed to reduce the risk of fire, electric shock, and injury to persons. These precautions include:

- ① Read all instructions before using this electric fireplace.
- ② This fireplace is hot when in use. To avoid burns, do not let bare skin touch hot surfaces. The trim around the heater outlet becomes hot during heater operation. Keep combustible materials, such as furniture, pillows, bedding, papers, clothes, and curtains at least 3 feet (0.9 m) from the front of the fireplace.
- ⚠ **DANGER:** High temperatures may be generated under certain abnormal conditions. Do not partially or fully cover or obstruct the front of the fireplace.
- ③ Extreme caution is necessary when the fireplace is used by or near children or people with disabilities and whenever the fireplace is left operating and unattended.
- ④ Young children should be supervised to ensure that they do not play with the appliance.
- ⑤ The appliance is not intended for use by young children or infirmed persons without supervision.
- ⑥ Do not operate the fireplace after it malfunctions, has been dropped, or damaged in any manner. Disconnect power at the service panel and have the fireplace inspected by a reputable electrician before using.
- ⑦ Do not use this fireplace outdoors.
- ⑧ Never locate the fireplace where it may fall into a bathtub or other water container.

- ⑨ To disconnect the heater, turn the unit off with the controls and turn off the power to the heater circuit at the main disconnect panel.
- ⑩ Do not locate the heater immediately below a fixed socket-outlet.
- ⑪ Do not insert or allow foreign objects to enter any ventilation or exhaust opening as this may cause an electric shock, fire, or damage to the fireplace.
- ⑫ To prevent a possible fire, do not block air intakes or exhaust in any manner.
- ⑬ All electrical heaters have hot and arcing or sparking parts inside. Do not use it in areas where gasoline, paint, or flammable liquids are used or stored.
- ⑭ Use this heater only as described in this manual. Any other use not recommended by the manufacturer may cause fire, electric shock or injury to persons.
- ⑮ Do not burn wood or other materials in this electric fireplace.
- ⑯ Do not strike the fireplace glass.
- ⑰ Always use a qualified technician or service agency to repair this fireplace.
- ⑱ Disconnect all power coming to the fireplace at the main service panel before performing any cleaning or maintenance.
- ⑲ When transporting or storing the fireplace, keep it in a dry place, free from excessive vibration, and store to avoid damage.

SAVE THESE INSTRUCTIONS



CAUTION
RISK OF ELECTRIC SHOCK
DO NOT OPEN
NO USER-SERVICEABLE PARTS INSIDE



IMPORTANT INSTRUCTIONS

 **WARNING:**

Remote control contains small batteries.
Keep away from children. If swallowed, seek medical attention immediately.

Do not install battery backwards, charge, put in fire or mix with used or other battery types - may explode or leak causing injury.

CALIFORNIA PROPOSITION 65 WARNING:

This product can expose you to chemicals including nickel which is known to the State of California to cause cancer. For more information, visit www.P65Warnings.ca.gov

 **FCC CAUTION:** Any changes or modifications not expressly approved by the party responsible for compliance could void the user's authority to operate this equipment.

Technical Specifications

Electrical Rating

Voltage: 120 V (3-Wire) or 240 V (4-Wire)

Power: 1500 W at 120 V, 2500 W at 240 V

UL Listing

File Number: E71416



Model Reference	
XLF50	690963XXXX
XLF60	691000XXXX
XLF74	690969XXXX
XLF100	690970XXXX

*XXXX indicates a non-safety critical suffix.

Product Dimensions

Figure 1



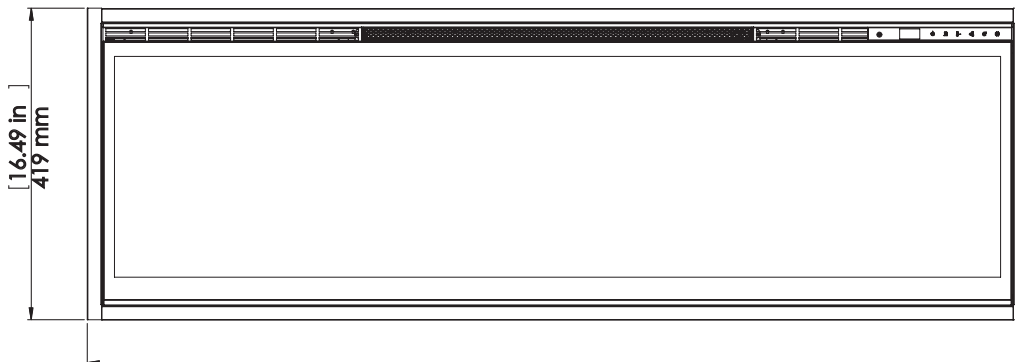
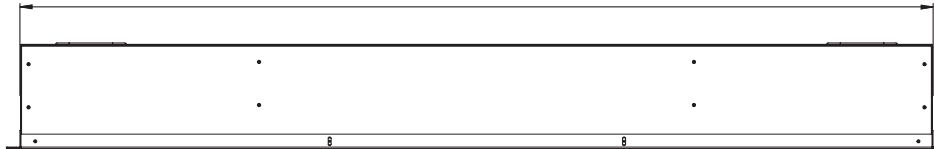



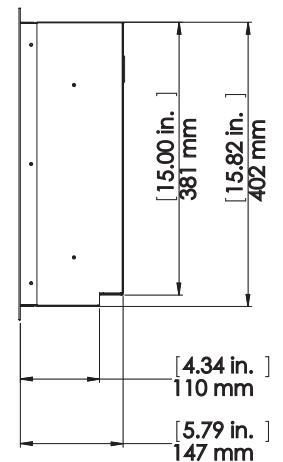

XLF50 50.31 in [1278 mm]
 XLF60 60.31 in [1532 mm]
 XLF74 74.31 in [1887 mm]
 XLF100 100.31 in [2548 mm]

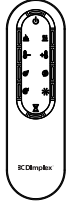
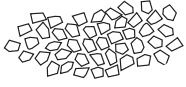



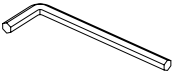

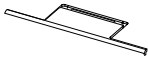
XLF50 51.41 in [1306 mm]
 XLF60 61.41 in [1560 mm]
 XLF74 75.41 in [1916 mm]
 XLF100 101.41 in [2576 mm]

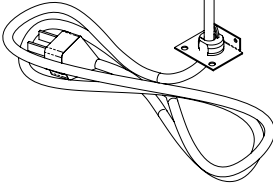

Package Contents

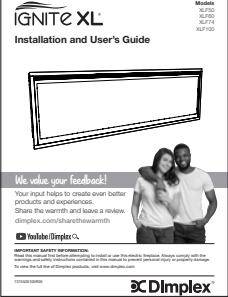
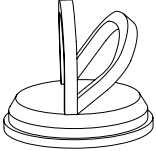
Image	Description	Quantity			
		XLF50	XLF60	XLF74	XLF100
	Remote Control	1	1	1	1
	Bag of Medium Acrylic Crystals	3	4	5	6
	Large Acrylic Crystals	12	14	18	24
	Firebox	1	1	1	1
	Front Glass	1	1	1	1
	Hex Key	1	1	1	1
	Black Screws (M4X10, button head)	2	2	4	4
	Screw Covers	2	2	4	4
	Mirrored Glass	1	1	1	1
	Power Cord	1	1	1	1

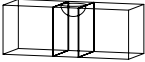
Package Contents

Image	Description	Quantity			
		XLF50	XLF60	XLF74	XLF100
	User's and Installation Guide	1	1	1	1
 <p><i>Do not dispose of the suction cup after installation. Keep it in a secure location as it will be helpful for maintenance and service of the unit.</i></p>	Suction Cup	0	1	1	1
	1 1/2" Wood Screws	4	4	4	4
	Bubble Level	1	1	1	1
	Twist-on Wire Connectors	4	4	4	4
	Wire Ties	2	2	2	2

*Package contents are subject to change

Installation

Placement

! **NOTE:** It is recommended that the bottom of the unit be mounted between 5" (13 cm) and 40" (102 cm) from the ground to maintain an optimized viewing angle of the flame.

⚠ **WARNING:** The top of the fireplace must be installed a minimum of 24" (61 cm) from the ceiling. The fireplace must be installed a minimum of 5" (13 cm) from the ground.

Installation in a Bathroom

If this unit is installed in a bathroom, it must be protected by a GFCI receptacle or circuit. If a receptacle is used, it must be readily accessible.

This electrical appliance is NOT watertight. To prevent electric shock, it must be installed as to prevent water from entering unit, or installed away from showers, tubs, etc. Never locate fireplace where it may fall into a bathtub or other water container.

Installation Recommendations for Overhanging Objects

For overhanging temperature-sensitive objects, such as a television, a mantel, or artwork, always follow the recommendations provided by its manufacturer for installation over a heater.

Figure 2 provides the overhang clearance recommendations for the fireplace. Areas above the fireplace are marked as follows:

- Solid gray box (■) is subject to temperatures greater than 65°C (149° F).
- Hatched box (▨) is subject to temperatures greater than 40°C (104° F).
- Clear box (□) is subject to temperatures less than 40°C (104° F).

Figure 2

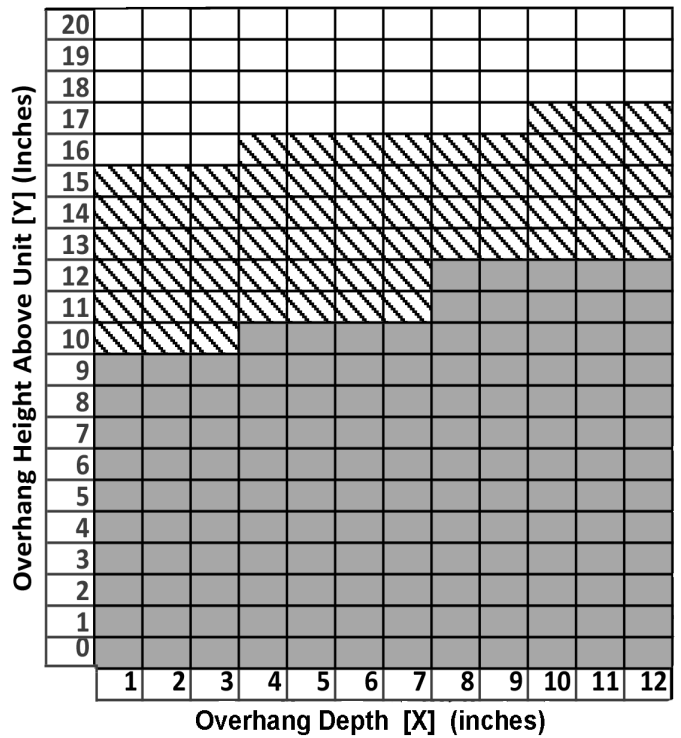

Installation Instructions

! **NOTE:** Two people are required for installation.

1. Prepare a wall with a framed opening, following the dimensions shown in **Figure 3**. The fireplace can either be installed partially-recessed (2x4 frame) or flush-mounted (2x6 frame).

⚠ **CAUTION:** Decorative finishing material (such as brick) should be limited to ½" (13 mm) overhang to ensure adequate flow of heated air out of the firebox area.

⚠ **CAUTION:** This fireplace is **NOT** load-bearing. Ensure the opening for the fireplace is framed in such a way that the weight of the building materials will not create pressure on the top of the fireplace.

! **NOTE:** For 2"x4" construction where the unit will be partially recessed, it is recommended to use XLFTRIM kit (sold separately) to accommodate the protruding portion of the fireplace.

Figure 3

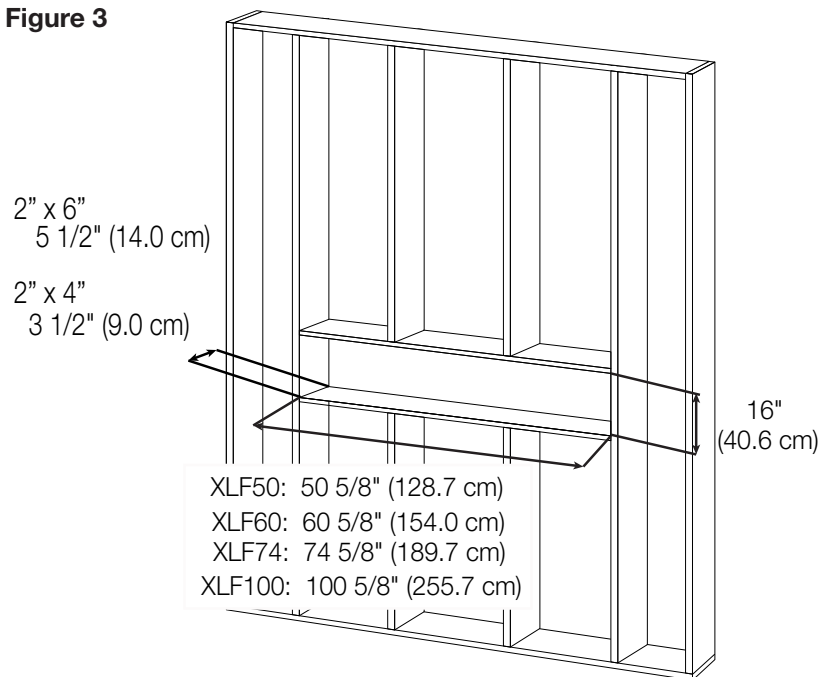

! **NOTE:** Wiring entry is located on the right side at the bottom of the firebox. Plan the framing to allow routing of the power cable to this location.

2. If a trimless installation is desired, remove the factory trim by removing the screws that secure it.

3. Ensuring a minimum of 18" (47 cm) of slack, route the supply power wire through a cable clamp (not included) and in the opening in the back of the unit. (Figure 4)

4. Lift the firebox into the opening in the frame using the handles on the back of the fireplace.

5. Using a bubble level (supplied) ensure that the fireplace is level within the framing. Adjust as required.

Figure 4

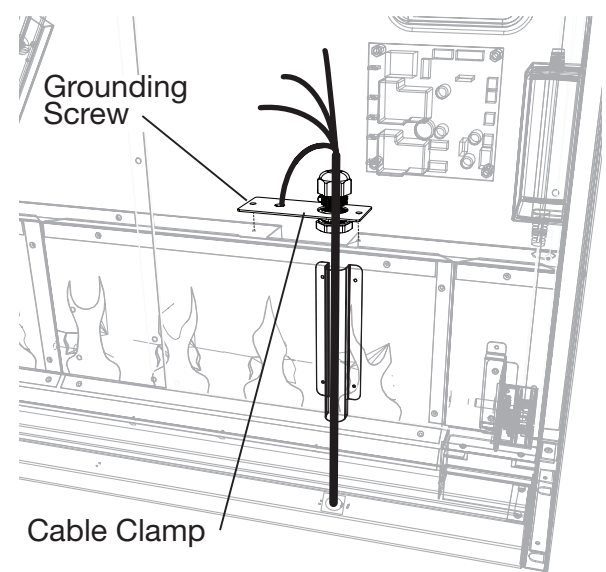

Installation

Figure 5

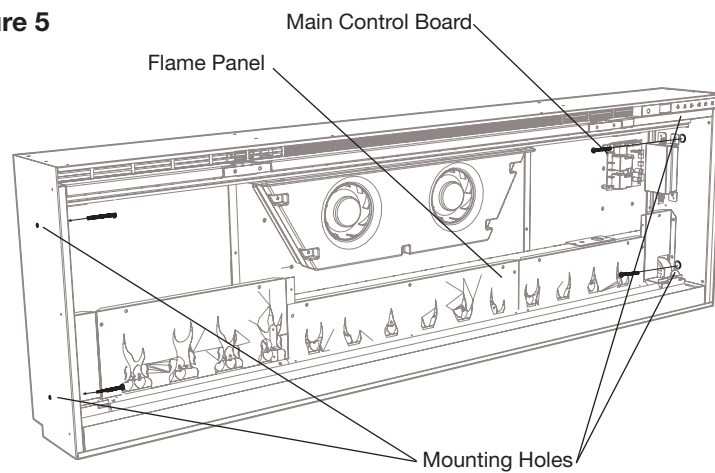

6. Drive four supplied mounting screws through the four mounting holes located on the inside surface of the fireplace chassis, into wall studs. (Figure 5)
7. Complete the wiring according to instructions in the *Electrical Installation* section (pages 12–13).
8. Complete the installation using the instructions in the following sections: *Mirrored Glass Installation* (page 15), *Arranging Media* (page 15), *Front Glass Installation* (page 16).

Electrical Installation

⚠ WARNING:

The installation of the electric fireplace must comply with the applicable Local and/or National Electrical Codes and utility requirements.

Use the appropriate wire to meet local and national electrical codes for rated power consumption.

⚠ CAUTION: A dedicated, properly fused 15 Amp circuit is recommended, rated for the appropriate voltage (120 V, 240 V). A dedicated circuit will be required if, after installation, the circuit breaker trips or fuse blows on a regular basis when the heater is operating. Additional appliances on the same circuit may exceed the current rating of the circuit breaker.

120 V Hardwire Installation

1. Cut the wire to an appropriate length.
2. Connect the black L1 wire from the unit to the live wire from the power supply with a wire connector.
3. Connect the white N wire from the unit to the neutral wire from the power supply with a wire connector.
4. Terminate the yellow L2 wire from the fireplace with a wire connector.
5. Connect the green G wire from the unit to the ground wire from the power supply with a wire connector or attach the grounding wire to the cover with the provided grounding screw, by placing the wire in between screw and lock washer and tighten.
6. Ensure all wire connections are tight and that wires are secured with wire ties and do not protrude past the flame panel, so as not to be visible after final installation.

Figure 6 120 V Hardwire Installation

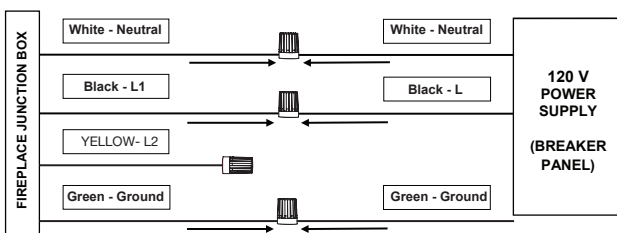

120V Installation – Wall Switch

! NOTE: Use a single pole, single throw (On/Off) wall switch that is rated for a minimum of 15 amps.

1. Cut the wire to an appropriate length.
2. Connect the black L1 wire from the unit to the live wire from the main power through the wall switch, ensuring all live connections are connected with a wire connector.
3. Connect the white N wire from the unit to the neutral wire from the power supply with a wire connector.
4. Terminate the yellow L2 wire from the fireplace with a wire connector.
5. Connect the green G wire from the unit to the ground wire from the power supply with a wire connector or attach the grounding wire to the cover with the provided grounding screw, by placing the wire in between screw and lock washer and tighten.
6. Ensure all wire connections are tight and that wires are secured with wire ties and do not protrude past the flame panel, so as not to be visible after final installation.

Figure 7 120 V Wall Switch Installation

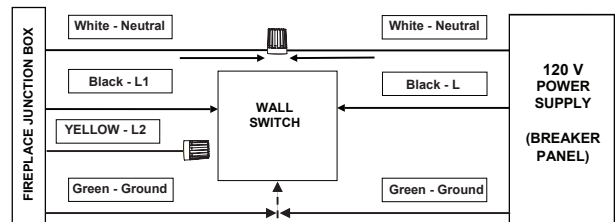

Installation

240 V Hardwire Installation

You will need a 4-wire 240 V supply (L1, L2, Neutral, and Ground).

1. Connect the black L1 wire from the unit to the L1 wire from the power supply with a wire connector.
2. Connect the yellow L2 wire from the unit to the L2 wire from the power supply with a wire connector.
3. Connect the white N wire from the unit to the neutral wire from the power supply.
4. Connect the green G wire from the unit to the ground wire from the power supply with a wire connector or attach the grounding wire.
5. Ensure all wire connections are tight and that wires are secured with wire ties and do not protrude past the flame panel, so as not to be visible after final installation.

Figure 8 240 V Hardwire Installation

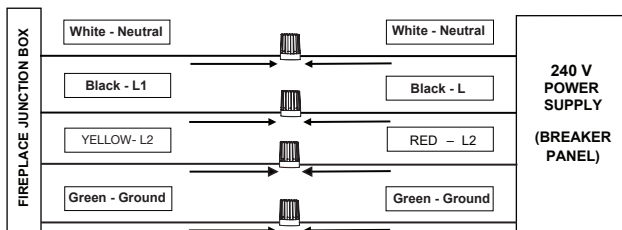

Power Cord Installation

⚠ WARNING: Power cord option is only suitable for 120 V installations.

1. Remove the 3 screws that secure the pre-installed hardwire plate.
2. Connect the black L1 wire from the unit to the black wire of the plug kit.
3. Connect the white N wire from the fireplace to the white wire from the plug kit.
4. Terminate the yellow L2 wire from the fireplace with a wire connector.
5. Connect green G wire from the fireplace to the green wire from the plug kit.
6. Ensure all wire connections are tight and that wires are secured with wire ties and do not protrude past the flame panel, so as not to be visible after final installation.
7. Secure the power cord's pre-installed cover plate using the screws removed when removing the hardwire plate. The previously removed electrical cover plate can be disposed of.

⚠ WARNING: This heater is not intended for use with an extension cord. Plug the cord directly into an appropriate grounded receptacle.

Figure 9

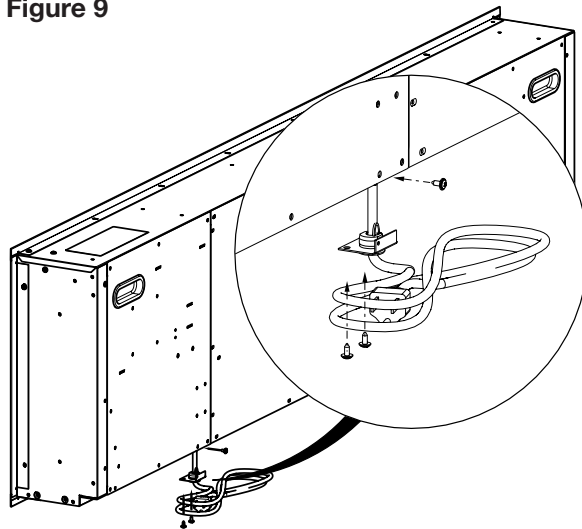

Heater Hardware Disconnect

The fireplace heater can be permanently disabled by removing the electronic jumper on the main control board.

! NOTE: Heater hardware disconnect will permanently disable the heater and fan. Follow these instructions only when an installation without heat is required. Temporary disabling of the heater can be achieved through the hidden touch controls. See “Heat Disable” in *Operation* section (page 18) for instructions.

To disconnect the heater and fan permanently:

1. Locate the main control board. The heater hardware disconnect jumper location is labeled “HT EN”. (Figure 10)
2. Pull out the heater hardware disconnect jumper.

Figure 10

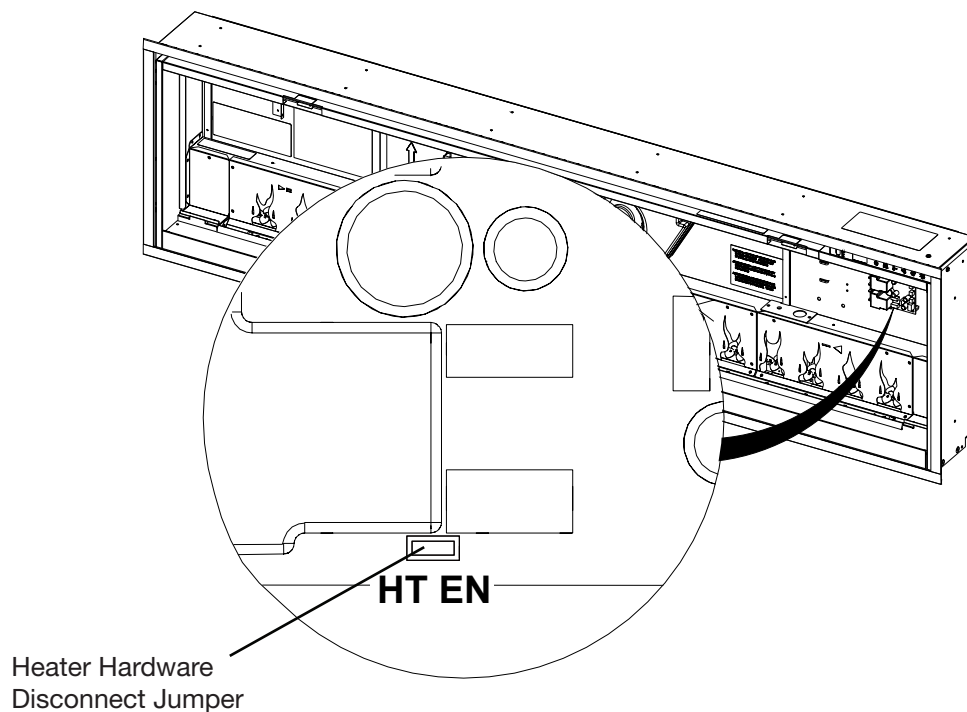

Mirrored Glass Installation

1. Locate and remove the screws securing the mirrored glass bracket to the unit, along the top of the opening, and set bracket and screws aside. (Figure 11)
 2. Remove the provided suction cup from the inside cavity of the unit (not found in XLF50 units).
 3. Ensure that the back of the glass is clean and free from particles and fingerprints.
 4. Secure the suction cup to the mirrored glass on the reflective side
 5. Lift the mirrored glass and place it into the supports on the bottom at either side of the unit.
 6. Tilt the mirrored glass into a vertical position.
 7. Secure the mirrored glass bracket to hold the glass in place, using the previously removed screws.
- ⚠ CAUTION:** Ensure the mirrored glass does not fall forward while the mirrored glass mounting bracket is being installed.
8. Remove the suction cup and clean any fingerprints or debris off the glass with a non-abrasive glass cleaner.
- ! NOTE:** Do not dispose of the suction cup! Keep it in a secure location, as it may be needed for maintenance and service on this fireplace.

Figure 11

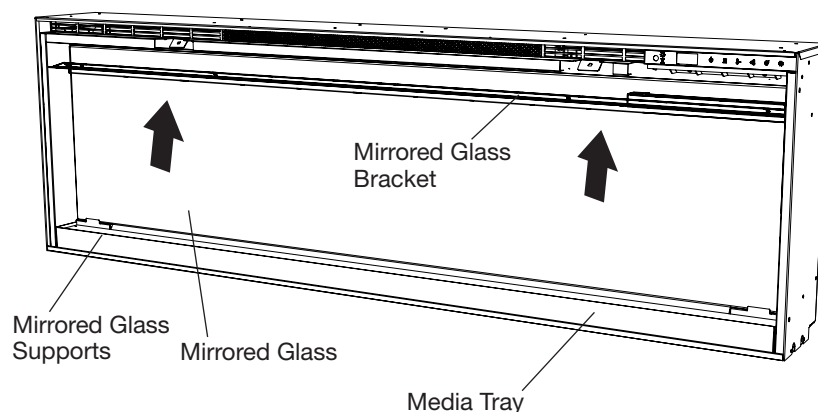

Media Arrangement

For best results when using the supplied media, arrange as follows:

1. Evenly space the large media in the media tray along the back of the media tray
2. Pour and evenly distribute the smaller crystals into the media tray.
3. If using the optional driftwood and river rock kit, evenly disperse the river rocks and place the driftwood pieces on top.

It is possible to use custom media ornaments to decorate your firebox. The custom media must fit easily without scratching the glass or bowing the media bed, and must not be composed of sand or liquid, which could interfere with the safety of the firebox.

Figure 12

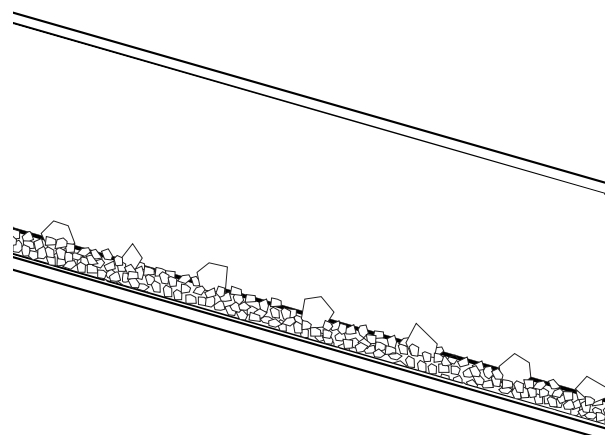

Front Glass Installation

1. Ensure that the mirrored glass and the inside of the front glass is clean and free from particles and fingerprints.
 2. Secure the suction cup (if provided) to the outside of the front glass.
 3. Lift the front glass and carefully place the front glass into the lip located at the bottom of the opening of the firebox.
 4. Tilt the glass into a vertical position.
 5. Secure the front glass using the provided screws and hex key. (Figure 13)
- ⚠ CAUTION:** Ensure the front glass does not fall forward while the securing screws are being installed.
6. Install the provided screw covers by placing the tabs of the screw cover between sides of the front glass bracket. (Figure 14)
- ! NOTE:** Do not dispose of the suction cup and hex key! Keep them in a secure location, as it may be needed for maintenance and service on this fireplace.

Figure 13

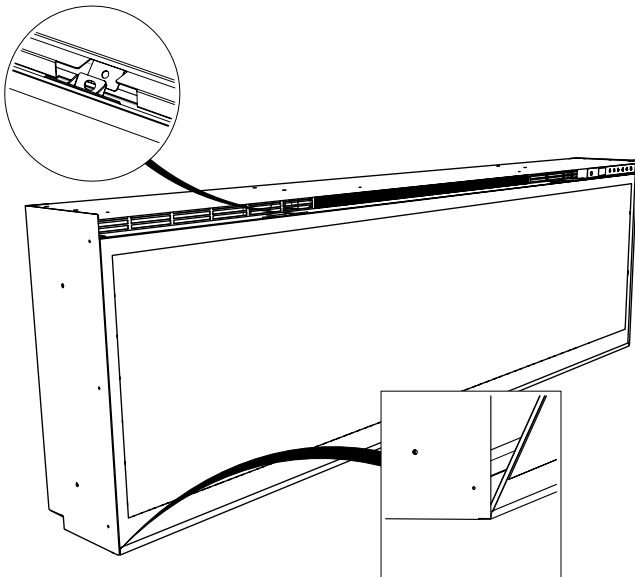
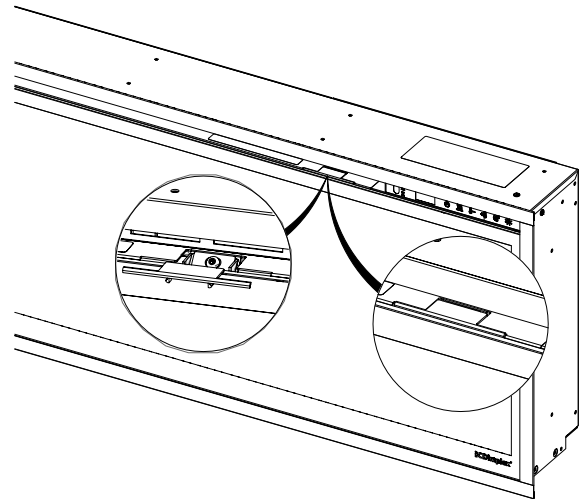

Figure 14



General Operation

⚠ WARNING: This electric firebox must be properly installed before it is used.

This firebox operates with ComfortSaver™ technology, which automatically adjusts the fan speed and heater wattage to safely and precisely match the requirements of the room based on the thermostat setting. The heater operates such that once the room reaches the set point, the fan and heater will continuously run at a low level, to maintain the desired room temperature. If the temperature in the room rises significantly, the heater will turn off and periodically turn back on to circulate the air around the unit, until the room temperature drops and requires the heater to be on again.

! NOTE: The element retains heat after shutdown. When the heat is turned off, there is a 2-minute cool down period before the fan shuts off completely.

! NOTE: The fireplace will retain the previously used settings after a power interruption.

Hidden Touch Controls

The hidden touch controls are located on the upper right of the fireplace. (Figure 15)

Remote Operation

The fireplace is supplied with a multifunction IR remote control. (Figure 16)

! NOTE: To operate correctly, the remote control must be pointed toward the front of the unit.

Figure 15

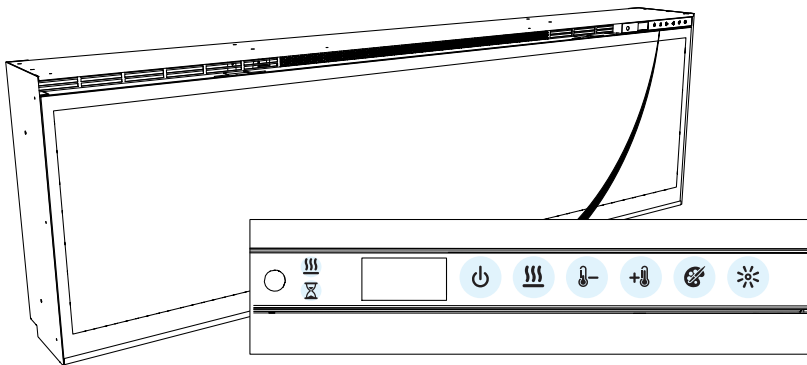
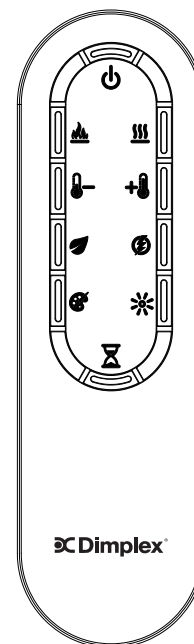



























Figure 16



Operation

	Standby	Press  to turn the unit on or put it in standby mode. When the unit is turned back on, it will retain the previously used settings.
	Flame Effect	Press  to turn the flame effect on or off.
	Heat	Press  to turn the heat on or off. The fireplace can be operated in heat only mode by turning off the flame and color effects.
	Heat Disable	Press and hold  and  at the same time for 3 seconds to disable or enable the heat function. This action must be performed on the hidden touch controls . When the heat is disabled and either the  ,  , or  is pressed, --- will appear on the display.
	Thermostat Control	Press  or  to adjust the temperature setting of the thermostat.
		When the temperature setting is adjusted, the set temperature will flash for 2 seconds, then the ambient room temperature will be displayed briefly. The temperature can be set from 5° C to 37° C (41° F to 99° F).
	Temperature Display (°C ↔ °F)	Press and hold  and  at the same time for 3 seconds. This action must be performed on the hidden touch controls .
	Eco Mode	Press  to activate Eco mode. In Eco Mode, the heater runs at reduced power to save energy.
	Heat Boost	Press  to activate Heat Boost and adjust the duration by 5 minute increments, up to 20 minutes. In Heat Boost, the heater runs at maximum power to quickly heat the space.
	Themes	Press  repeatedly to cycle through the 8 different Themes: 1 - White 2 - White with orange accents 3 - White with blue accents 4 - Red 5 - Blue 6 - Prism — media bed cycles through colors 7 - Kaleidoscope— media bed cycles through colors at different rates 8 - Midnight mode — media bed lights are off
	Custom Color	Freeze the media lights to a custom color. When in Prism or Kaleidoscope modes (see Themes), press  while the desired color is displayed to freeze the cycle on that color. Press  again to resume the color cycle.

Operation



Brightness

Press repeatedly to cycle through the brightness and flicker modes.

Solid *H* - High Brightness

Solid *L* - Low Brightness

Cycle *H* - High Brightness with flickering media

Cycle *L* - Low Brightness with flickering media



Timer

Press repeatedly until the desired number of hours of the timer is displayed. When this function is active, the fireplace will turn off after a set amount of time. The timer can be set from 30 minutes to 8 hours in intervals of 30 minutes.

To turn the timer off, press repeatedly until appears on the display.

While the timer is active, press the timer button to see the time remaining.

Factory Reset

Press and hold and at the same time for 3 seconds to restore the unit to its factory default settings.

Resetting the Temperature Cutoff Switch

Should the heater overheat, a manual limit cut-out will turn the unit off and it will not come back on without being reset. If the button on the unit is pressed, *Er2* will be displayed on the unit. It can be reset by turning the unit off at the main disconnect panel and waiting 5 minutes before turning the unit back on.

⚠ CAUTION: If you need to continuously reset the heater, turn the unit off at the main disconnect panel and call technical support at: 1-888-346-7539.

Maintenance

Remote Control Battery Replacement

To replace the battery:

Slide battery cover open on the remote control.

Correctly install one 3 Volt (CR2032 [longer life] or CR2025) battery in the battery holder with the + side facing up.

Close the battery cover.



The battery must be recycled or disposed of properly. Check with your Local Authority or Retailer for recycling advice in your area.

⚠ WARNING: Disconnect power and allow heater to cool before attempting any maintenance or cleaning to reduce the risk of fire, electric shock or damage to persons.

Cleaning

Mirrored Glass Cleaning

The mirrored glass is cleaned in the factory during the assembly operation. During shipment, installation, handling, etc., the mirrored glass may collect dust particles; these can be removed by dusting lightly with a clean dry cloth.

To remove fingerprints or other marks, the mirrored glass can be cleaned with a damp cloth. The mirrored glass should be completely dried with a lint-free cloth to prevent water spots. To prevent scratching, do not use abrasive cleaners.

Fireplace Surface Cleaning

Use only a damp cloth to clean painted surfaces of the fireplace. Do not use abrasive cleaners.



The fireplace should not be operated with an accumulation of dust or dirt on or in the unit, as this can cause a build-up of heat and eventual damage. For this reason the heater must be inspected regularly, depending upon conditions and at a minimum yearly intervals.

Servicing

Except for installation and cleaning described in this manual, an authorized service representative should perform any other servicing.

Troubleshooting

For more troubleshooting, consult the XLF Service Manual which can be found at www.dimplex.com/product-downloads

Problem	Display	Cause	Solution
Fireplace does not turn on with the manual touch controls	N/A	No incoming power	Ensure unit is wired correctly Check main disconnect panel Ensure wall switch is on (if applicable)
Fireplace does not turn on with the remote control	N/A	The batteries in the remote control are dead or installed incorrectly	Replace remote control battery Ensure battery is installed with + facing up.
Heater does not turn on	---	Heater is disabled	Press and hold  and  at the same time on the hidden touch controls for 3 seconds to disable or enable the heat function.
	H--	Heater has been permanently disabled	If installation with heat is desired, reinstall jumper on main board if available or purchase new main board.
	Er 1	Thermistor problem	See service manual.
	Er 2	High temperature cut-out is activated	Ensure heater is free from obstructions. Reset breaker and wait 5 minutes before turning unit back on it. If error persists, see Service Manual.
Heater is on, but there is no heat		Normal operation — There is a 30-second delay before heater starts	No action required.
Circuit breaker trips or fuse blows when unit is turned on	N/A	Improper circuit current rating	Install unit on a dedicated minimum 15 amp circuit.

Wiring Diagrams

XLF50

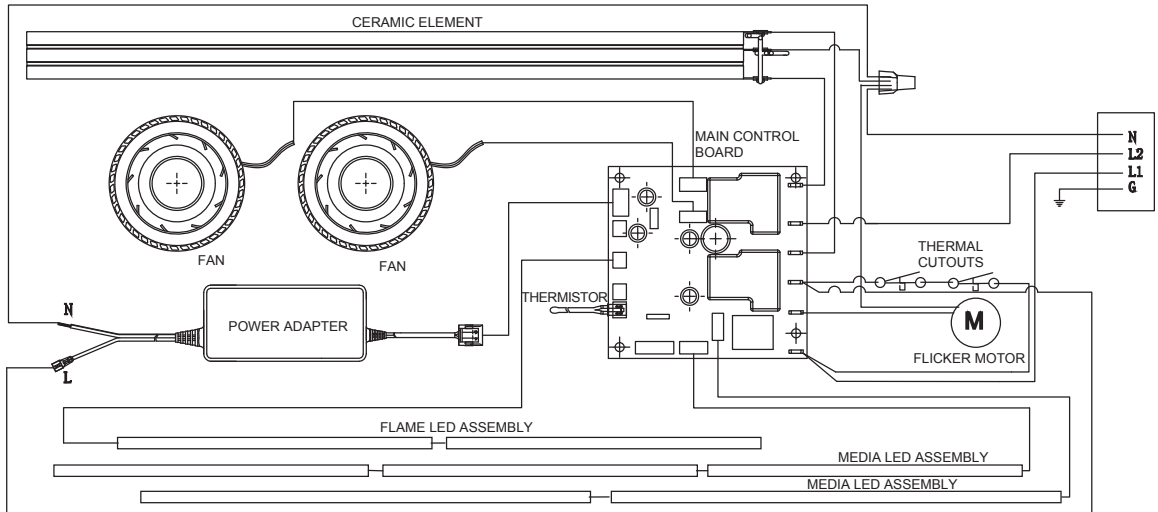

XLF60

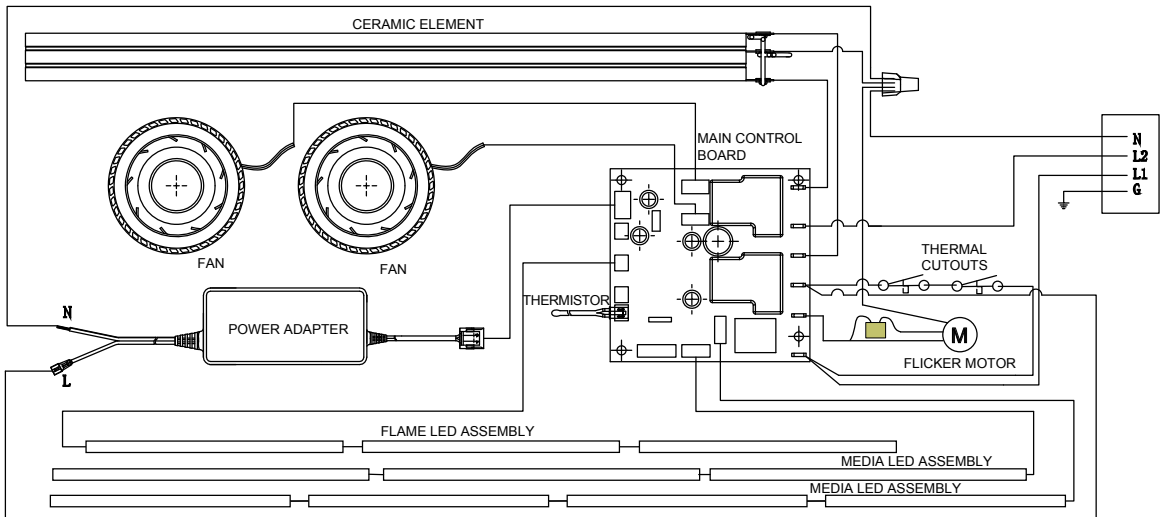

XLF74 XLF100

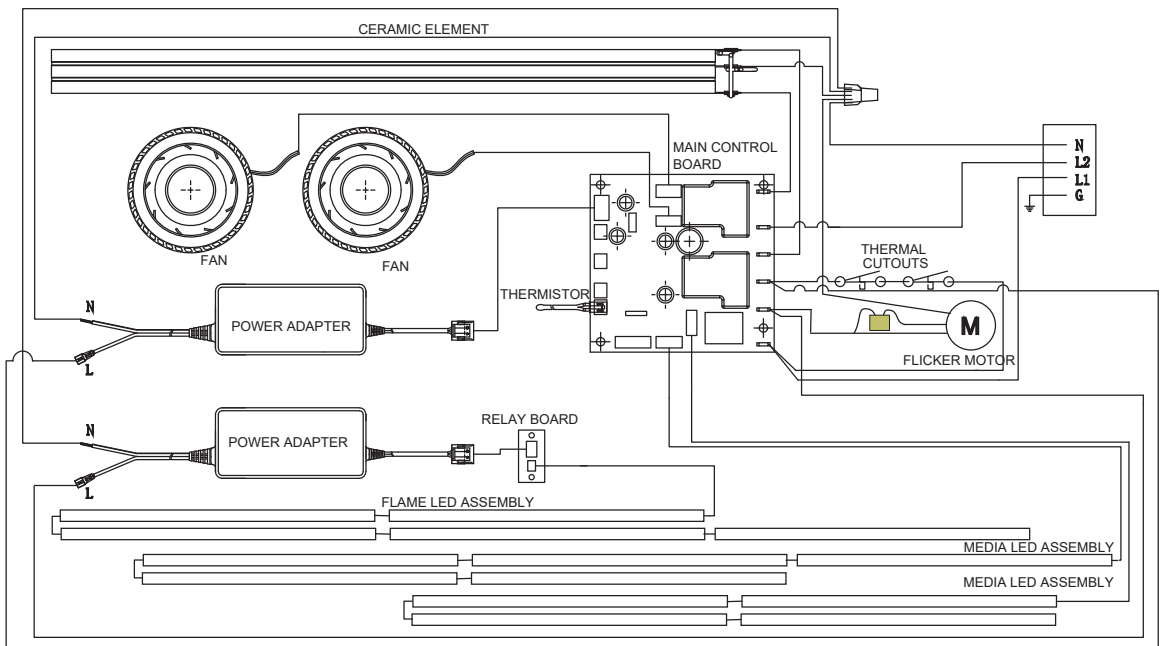

Warranty

IGNITEXL® 5-YEAR LIMITED WARRANTY

Section 1 Products to which this Limited Warranty Applies

This Limited Warranty applies to your newly purchased Dimplex electric fireplace with model numbers XLF50, XLF60, XLF74, and XLF100.

This Limited Warranty applies only to purchases made in any province of Canada except for Yukon Territory, Nunavut, or Northwest Territories or in any of the 50 States of the USA and the District of Columbia except for Hawaii and Alaska. This Limited Warranty applies to the original purchaser of the product only and is not transferable.

Section 2 Products excluded from this Limited Warranty

Products purchased in Yukon Territory, Nunavut, Northwest Territories, Hawaii, or Alaska are not covered by this Limited Warranty. Products purchased in these States, Provinces, or Territories are sold AS IS without Warranty or condition of any kind including, without limitation, any implied warranties or conditions of merchantability or fitness for a particular purpose. The entire risk of as to the quality and performance of the products is with the purchaser. In the event of a defect, the purchaser assumes the entire cost of all necessary servicing or repair.

Section 3 What this Limited Warranty covers and for How Long

IgniteXL® products XLF50, XLF60, XLF74, and XLF100 excluding trims and accessory packages are covered by this Limited Warranty, have been tested and inspected prior to shipment and, subject to the provisions of this Warranty, Glen Dimplex Americas Ltd. (herein called Glen Dimplex Americas) warrants such products to be free from defects in material and workmanship for a period of 5 years from the date of the first purchase of such products. The 5-year Limited Warranty entitles the purchaser to On-site or In-home Warranty Services. Accordingly, Glen Dimplex Americas will be responsible for all labor and transportation associated with repairing or replacing the product or part. Exceptions to this are outlined in Section 5. Some jurisdictions do not allow limitations on how long an implied Warranty lasts, so the above limitation may not apply to the purchaser.

Section 4 What this Limited Warranty Does Not Cover

This Limited Warranty does not apply to products that have been repaired (except by Glen Dimplex Americas or its authorized service representatives) or otherwise altered. This Limited Warranty does further not apply to defects resulting from misuse, abuse, accident, neglect, incorrect installation, improper maintenance or handling, or operation with an incorrect power source.

Section 5 How to notify us of a Warranty Concern

Defects must be brought to the attention of Dimplex Customer Service online at dimplex.com/en/contact_us or by telephone at 1-888-346-7539. Please have proof of purchase, catalogue/model and serial numbers available for representatives to assist. **Limited In-home Warranty Services require proof of purchase.

In the event a product or part covered by this Limited Warranty is proven to be defective in material or workmanship during (i) the 5-year Limited Warranty period for products outlined in Section 1, you have the following rights:

- Glen Dimplex Americas will in its sole discretion either repair or replace such defective product or part without charge. If Glen Dimplex Americas is unable to repair or replace such product or part, or if repair or replacement is not commercially practicable or cannot be timely made, Glen Dimplex Americas may, in lieu of repair or replacement, choose to refund the purchase price for such product or part.
- Limited Warranty service will be performed solely by dealers or service agents of Glen Dimplex Americas authorized to provide Limited Warranty services.
- This 5-year Limited Warranty entitles the purchaser to On-site or In-home Warranty services. Accordingly, Glen Dimplex Americas will be responsible for all labor and transportation associated with repairing or replacing the product or part except as follows: (i) charges which may be levied for travel costs incurred to travel to the purchaser's site where the product is located if the purchaser's site is beyond 30 miles (48 km) from the closest service depot of Glen Dimplex Americas dealer or service agent; and (ii) the purchaser is solely responsible for providing clear access to all serviceable parts of the product.
- Glen Dimplex Americas will not be responsible for, and this Limited Warranty shall not include, any expense incurred for installation or removal of the surrounds (mantels) or trims or any part thereof (or any replacement product or part) including, without limitation, all shipping costs and transportation costs to and from the authorized dealer's or service agent's place of business and all labor costs. Such costs shall be the purchaser's sole responsibility.

Section 6 When Glen Dimplex Americas and its Dealers and Service Agents are not Liable

IN NO EVENT WILL GLEN DIMPLEX AMERICAS, OR ITS DIRECTORS, OFFICERS, OR AGENTS, BE LIABLE TO THE PURCHASER OR ANY THIRD PARTY. WHETHER IN CONTRACT, IN TORT, OR ON ANY OTHER BASIS, FOR ANY INDIRECT, SPECIAL, PUNITIVE, EXEMPLARY, CONSEQUENTIAL, OR INCIDENTAL LOSS, COST, OR DAMAGE ARISING OUT OF OR IN CONNECTION WITH THE SALE, MAINTENANCE, USE, OR INABILITY TO USE THE PRODUCT, EVEN IF GLEN DIMPLEX AMERICAS OR ITS DIRECTORS, OFFICERS, OR AGENTS HAVE BEEN ADVISED OF THE POSSIBILITY OF SUCH LOSSES, COSTS OR DAMAGES, OR IF SUCH LOSSES, COSTS, OR DAMAGES ARE FORESEEABLE. IN NO EVENT WILL GLEN DIMPLEX AMERICAS, OR ITS OFFICERS, DIRECTORS, OR AGENTS BE LIABLE FOR ANY DIRECT LOSSES, COSTS, OR DAMAGES THAT EXCEED THE PURCHASE PRICE OF THE PRODUCT. SOME JURISDICTIONS DO NOT ALLOW THE EXCLUSION OR LIMITATION OF INCIDENTAL OR CONSEQUENTIAL DAMAGES, SO THE ABOVE LIMITATION OR EXCLUSION MAY NOT APPLY TO THE PURCHASER.

How State and Provincial law(s) apply

This Limited Warranty gives you specific legal rights, and you may also have other rights which vary from jurisdiction to jurisdiction. The provisions of the United Nations Convention on Contracts for the Sale of Goods shall not apply to this Limited Warranty or the sale of products covered by this Limited Warranty.

We value your feedback!

Your input helps to create even better products and experiences.

Share the warmth and leave a review.

dimplex.com/sharethewarmth

 [YouTube/Dimplex](https://www.youtube.com/Dimplex) 



1-888-346-7539 | www.dimplex.com

In keeping with our policy of continuous product improvement, we reserve the right to make changes without notice.

© 2023 Glen Dimplex Americas

 **A BRAND OF GLEN DIMPLEX AMERICAS**